

## STANDARD LADDER PARTS

**BOLTS PER PAIR**  
4 No. M12 x 40 CUP HEAD BOLTS  
c/w NUT + FRW

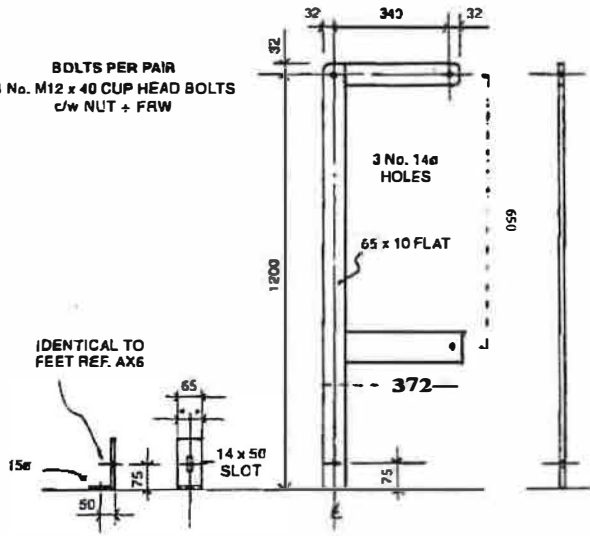

**EXTENSION TO FLOOR REF AX4**  
(SOLD IN PAIRS)

**FIT EYE BOLT HERE**  
IF NOT USING EXTENSION AX4

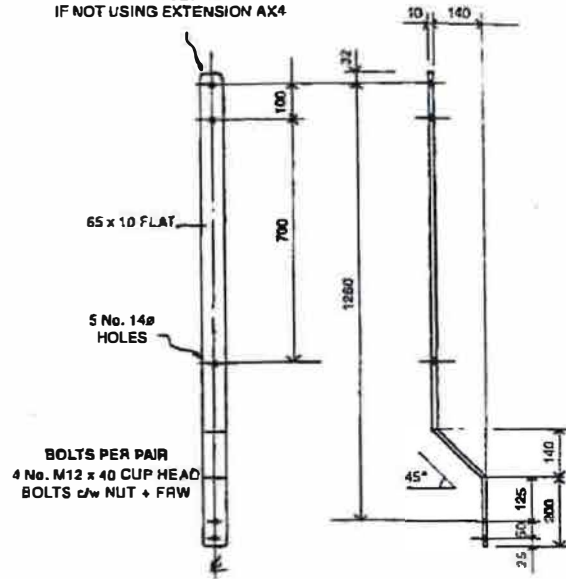

**BOLTS PER PAIR**  
4 No. M12 x 40 CUP HEAD  
BOLTS c/w NUT + FRW

**LADDER EXTENSION REF AX3**  
(SOLD IN PAIRS)

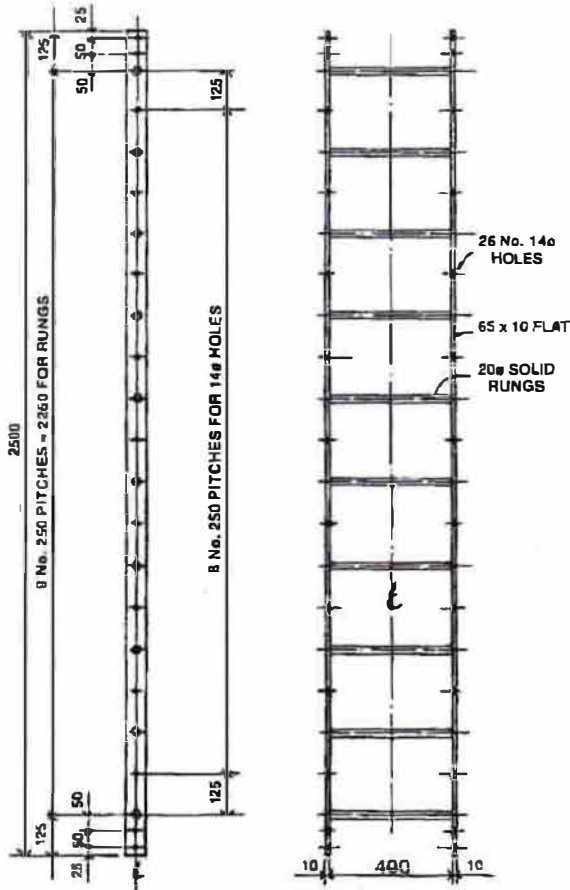

**LONG LADDER SECTION REF AX1**

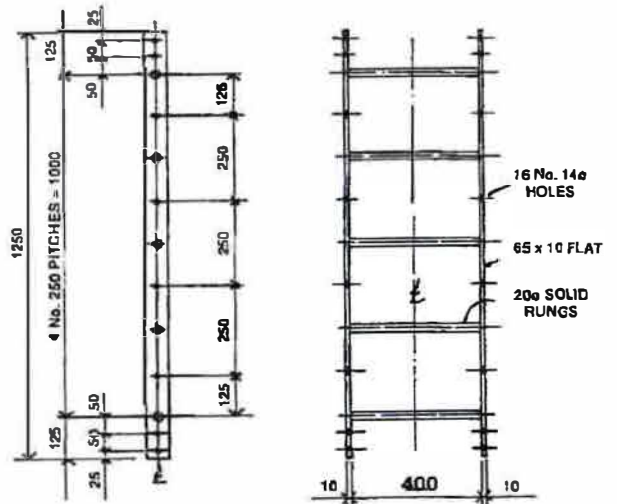

**SHORT LADDER SECTION REF AX2**

**BOLTS PER PAIR**  
2 No. M12 x 40 CUP HEAD  
BOLTS c/w NUT + FRW

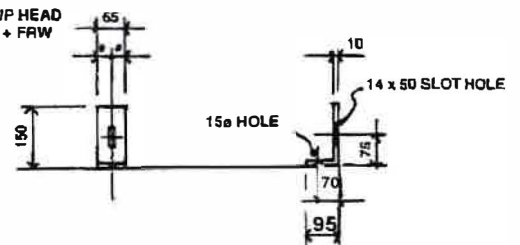

**LADDER FEET REF AX6** (SOLD IN PAIRS)

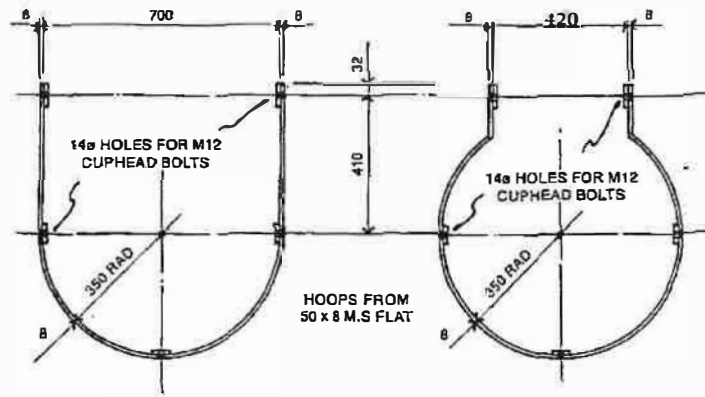

**BOLTS PER HOOP**  
5 No. M12 x 40 CUP HEAD  
BOLTS c/w NUT + FRW

**TOP HOOPS REF. AX8**

**LOWER HOOPS REF. AX9**

**NOTE! 50 x 8 M.S. FLAT CAGE STRAPS SUPPLIED IN LENGTHS AS BELOW**

**BOLTS PER SET**  
4 No. M12 x 40 CUP HEAD  
BOLTS c/w NUT + FRW

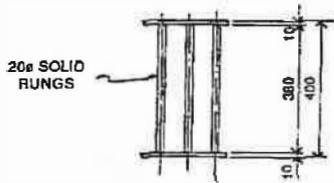

**20ø SOLID RUNGS**

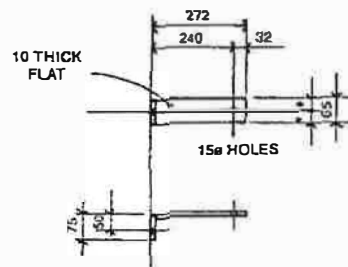

**10 THICK FLAT**

**BOLTS PER PAIR**  
2 No. M12 x 40 CUP HEAD  
BOLTS c/w NUT + FRW

**LADDER STAY REF. AX7 (SOLD IN PAIRS)**

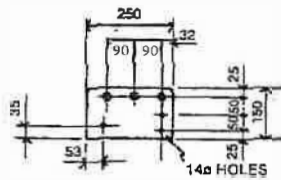

**TOP STEP DETAIL REF. AX5**  
(ITEM AX10 REQUIRED TO FIX TO AX1 OR 2)

**BOLTS PER PAIR**  
8 No. M12 x 40 CUP HEAD  
BOLTS c/w NUT + FRW

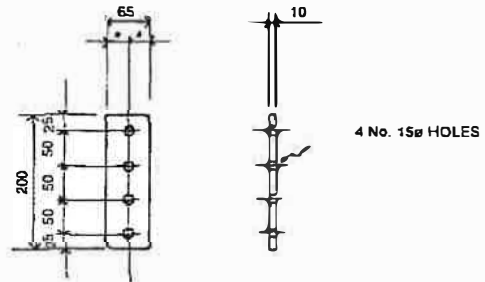

**4 No. 15ø HOLES**

**SPLICE PLATES REF. AX10 (SOLD IN PAIRS)**

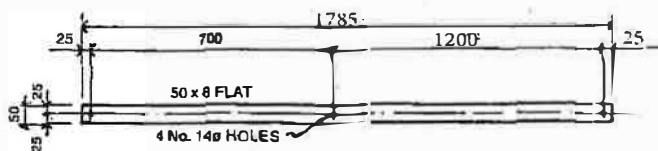

**TOP CAGE STRAP REF. AX11**

**NOTE! ITEMS AX11, AX12, AX13, AX14  
MUST ALWAYS BE SUPPLIED  
IN SETS OF 5no.**

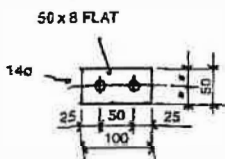

**CAGE SPLICE REF. AX13**

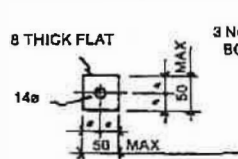

**CAGE SPLICE PACKER REF. AX14**

**PER SET OF 3**  
3 No. M12 x 40 CUP HEAD  
BOLTS c/w NUT + FRW

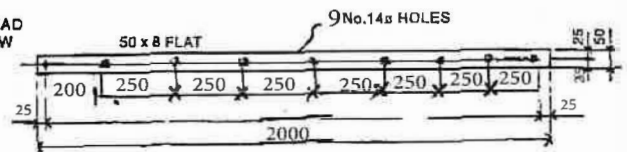

**LOWER CAGE STRAP REF. AX12**

**NOTE! ITEMS AX13 & AX14 MUST ALWAYS BE SUPPLIED WITH STRAP REF. AX12**